

KOCAELİ SANAYİ ODASI

PROSES
EMNİYETİ SEMPOZYUMU

VANA KONTROL SİSTEMLERİNDE ASSET MANAGEMENT VE ÖNEMİ

OĞUZHAN ÖZÇELİK

09-10 NİSAN 2019



ASSET MANAGEMENT ve ÖNEMİ

ASSET / VARLIK NEDİR?

ISO 55000'e göre,

Bir kuruluş için potansiyel
veya mevcut değeri olan
tüm nesnelerdir.



ASSET MANAGEMENT ve ÖNEMİ

ASSET MANAGEMENT NEDİR?

ISO 55000'e göre,

Bir kuruluşun, varlıklarından değer üretmek için koordine ettiği aktivitelerdir.



ASSET MANAGEMENT ve ÖNEMİ

ASSET MANAGEMENT NEDEN GEREKLİDİR?

Emniyetli İşletme

Varlıkların Ömürleri Müddetince Sebep Olabilecekleri
Maliyetlerde Kayda Değer İyileştirme

Detaylı Risk Yönetimi

Yükümlülükleri Yerine Getirmede Kolaylık

Geleceğe Dair Farklı Performans/Maliyet/Risk
Değerlendirmesi Yapabilme

Verim ve Etkinlikte İyileşme

Yükseltilmiş Marka Değeri



ASSET MANAGEMENT ve ÖNEMİ

BİR YOLCULUK: ASSET MANAGEMENT

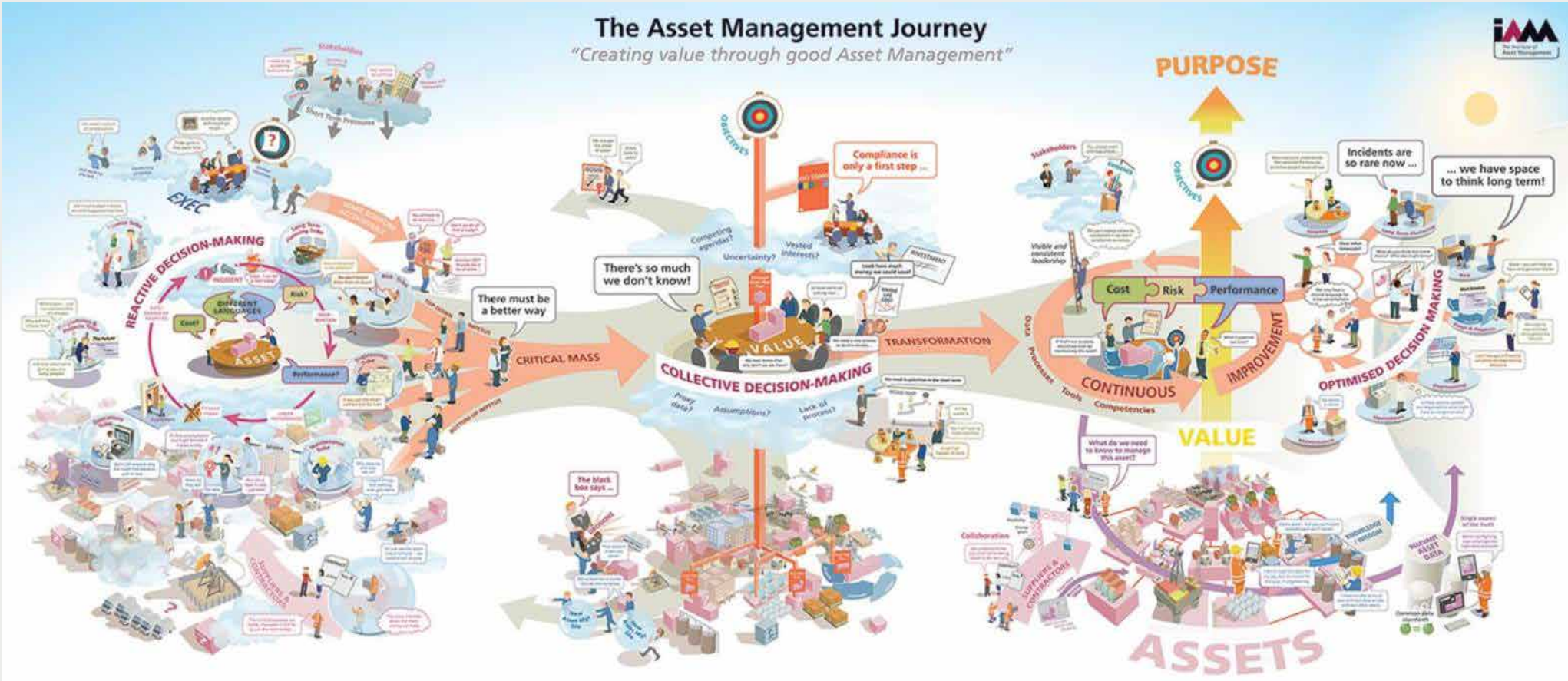

ASSET MANAGEMENT ve ÖNEMİ

VANA KONTROL SİSTEMLERİNDE ASSET MANAGEMENT

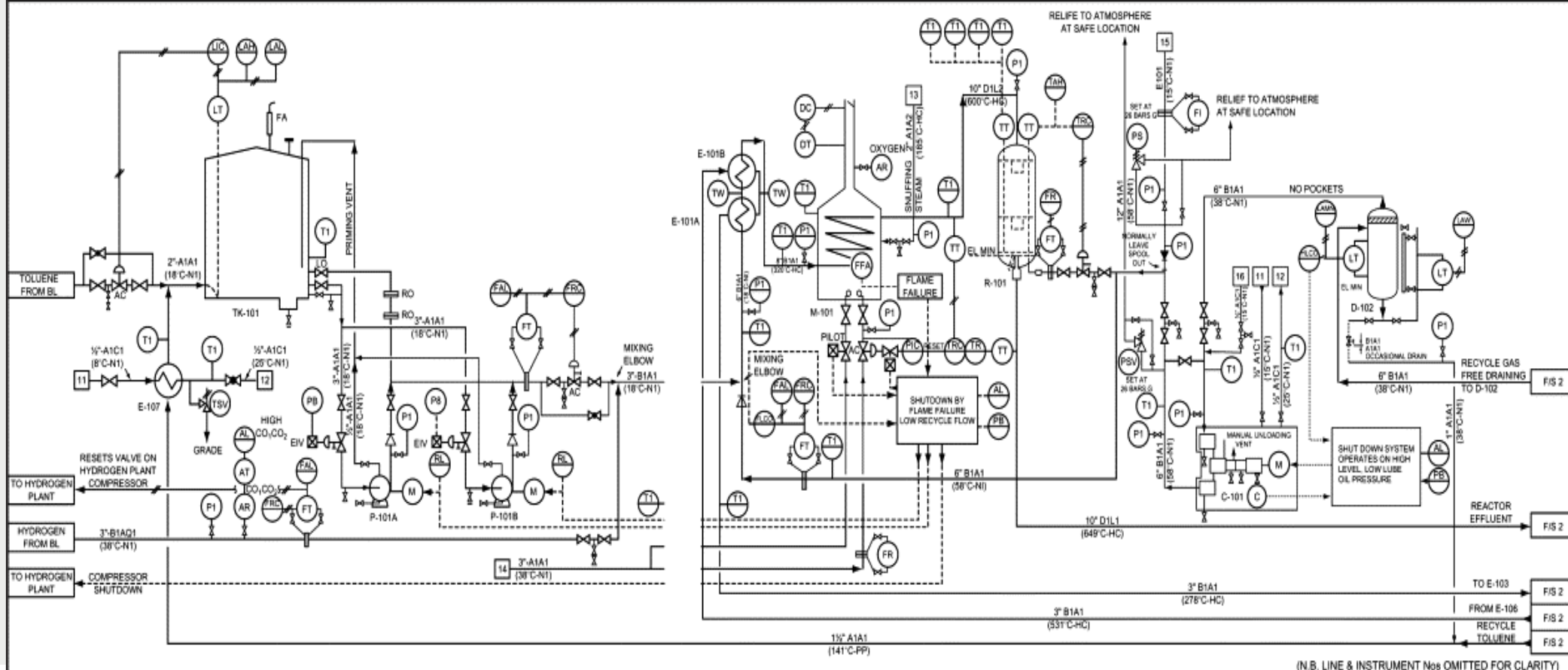

KOCAELİ SANAYİ ODASI

PROSES
EMNİYETİ SEMPOZYUMU

ASSET MANAGEMENT ve ÖNEMİ

VANA KONTROL SİSTEMLERİNDE ASSET MANAGEMENT

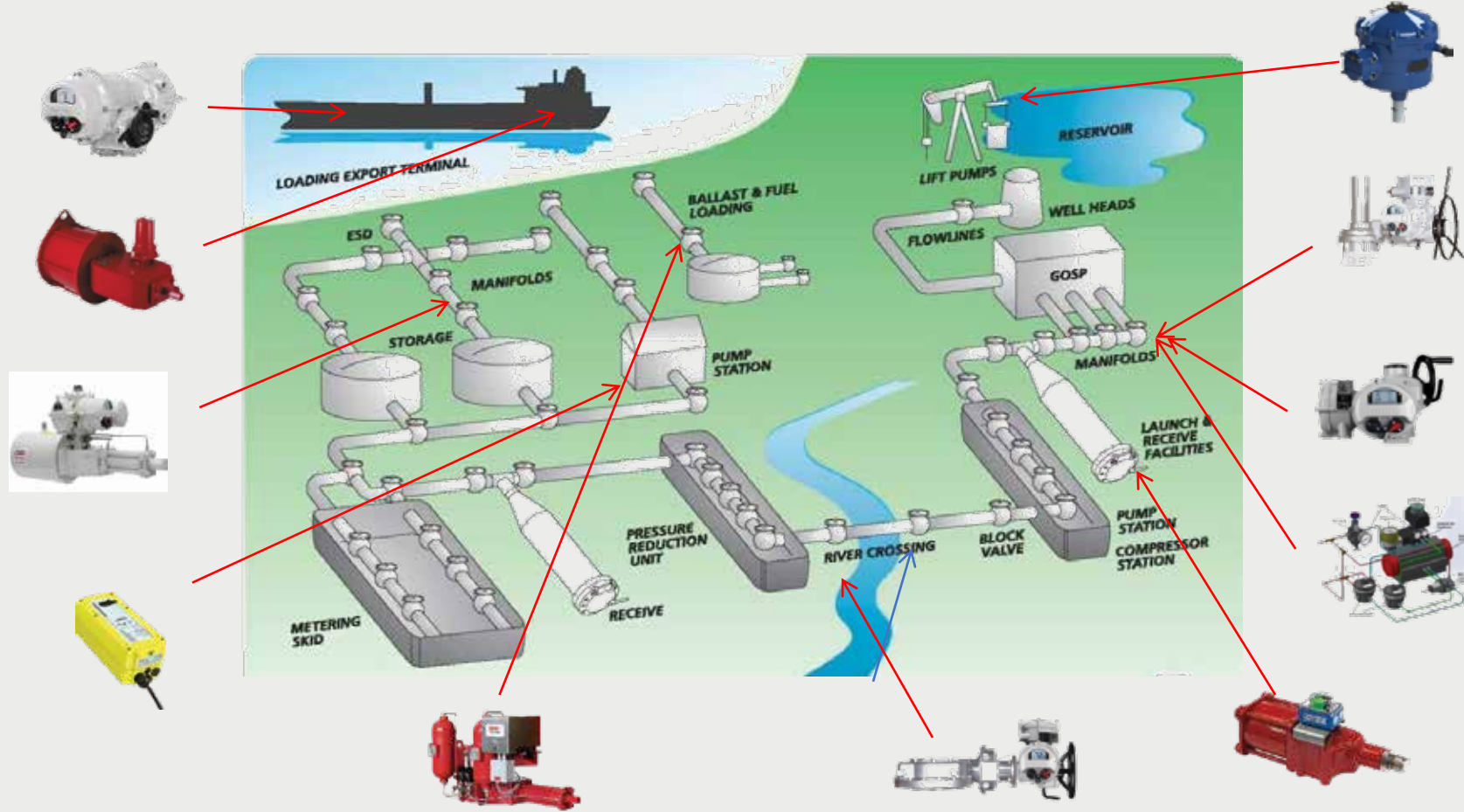

ASSET MANAGEMENT ve ÖNEMİ

VANA KONTROL SİSTEMLERİNDE ASSET MANAGEMENT

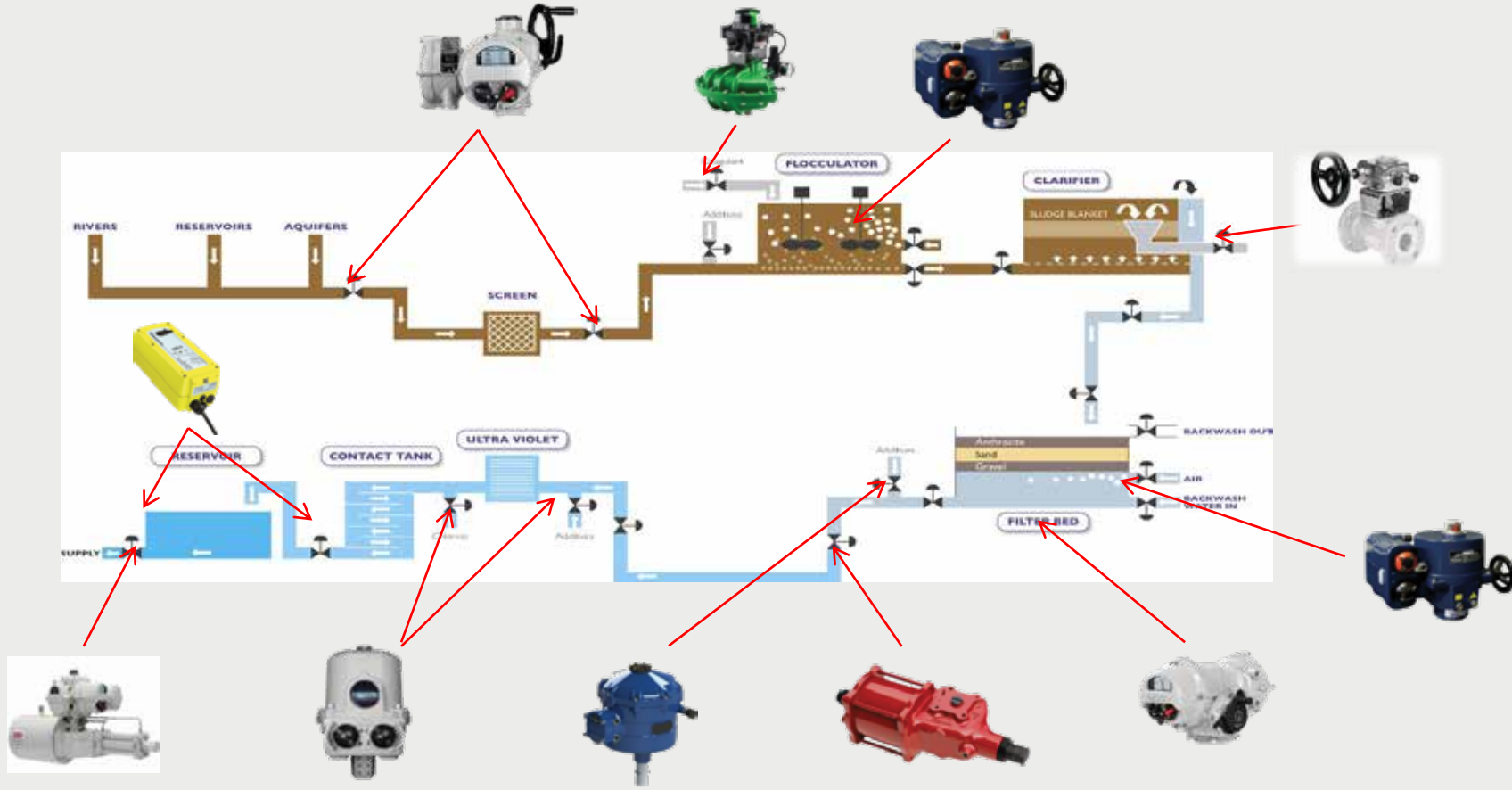

KOCAELİ SANAYİ ODASI

PROSES
EMNİYETİ SEMPOZYUMU

ASSET MANAGEMENT ve ÖNEMİ

VANA KONTROL SİSTEMLERİNDE ASSET MANAGEMENT

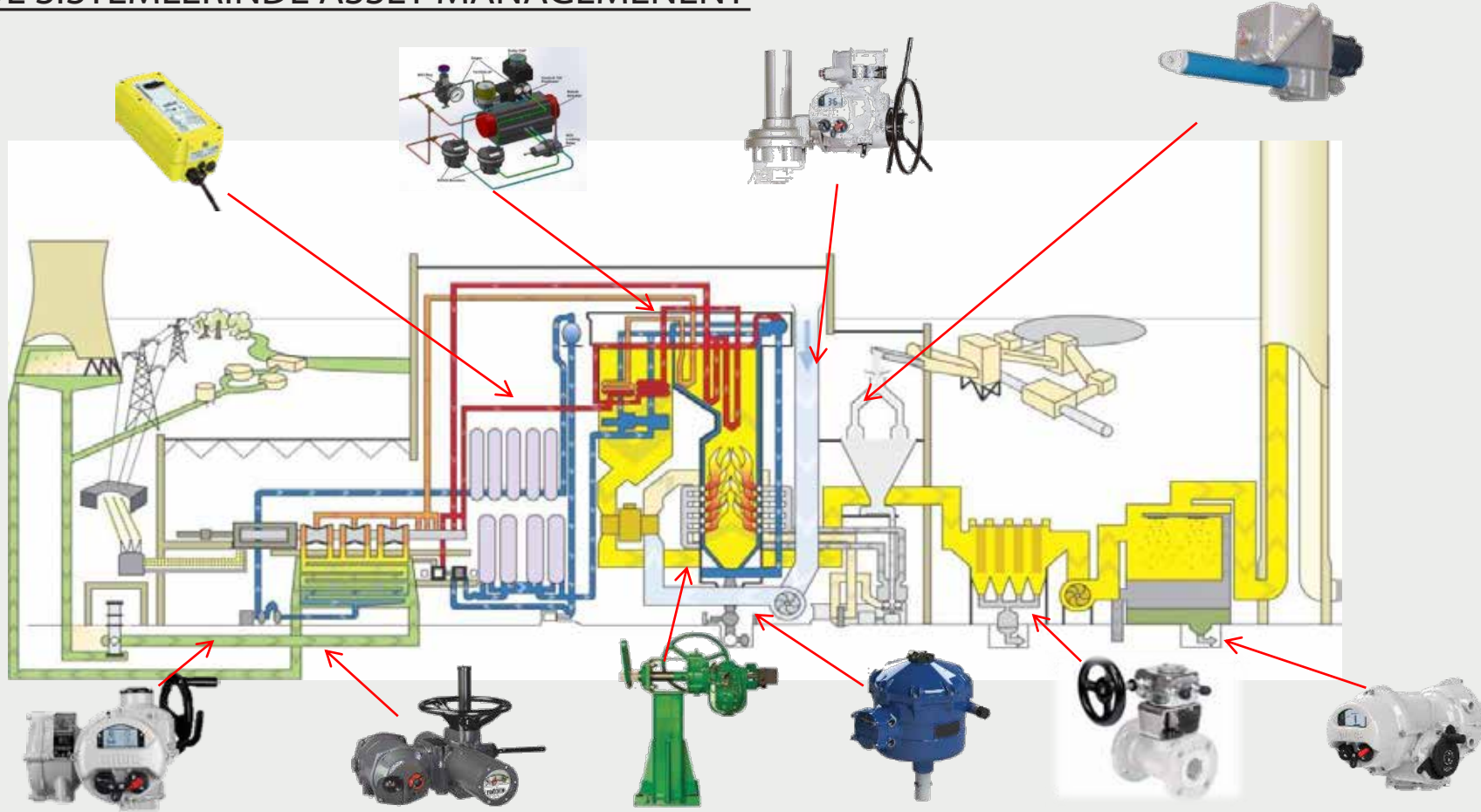

KOCAELİ SANAYİ ODASI

PROSES
EMNİYETİ SEMPOZYUMU

ASSET MANAGEMENT ve ÖNEMİ

VANA KONTROL SİSTEMLERİNDE ASSET MANAGEMENT

Pakscan™

DeviceNet
CONFORMANCE TESTED

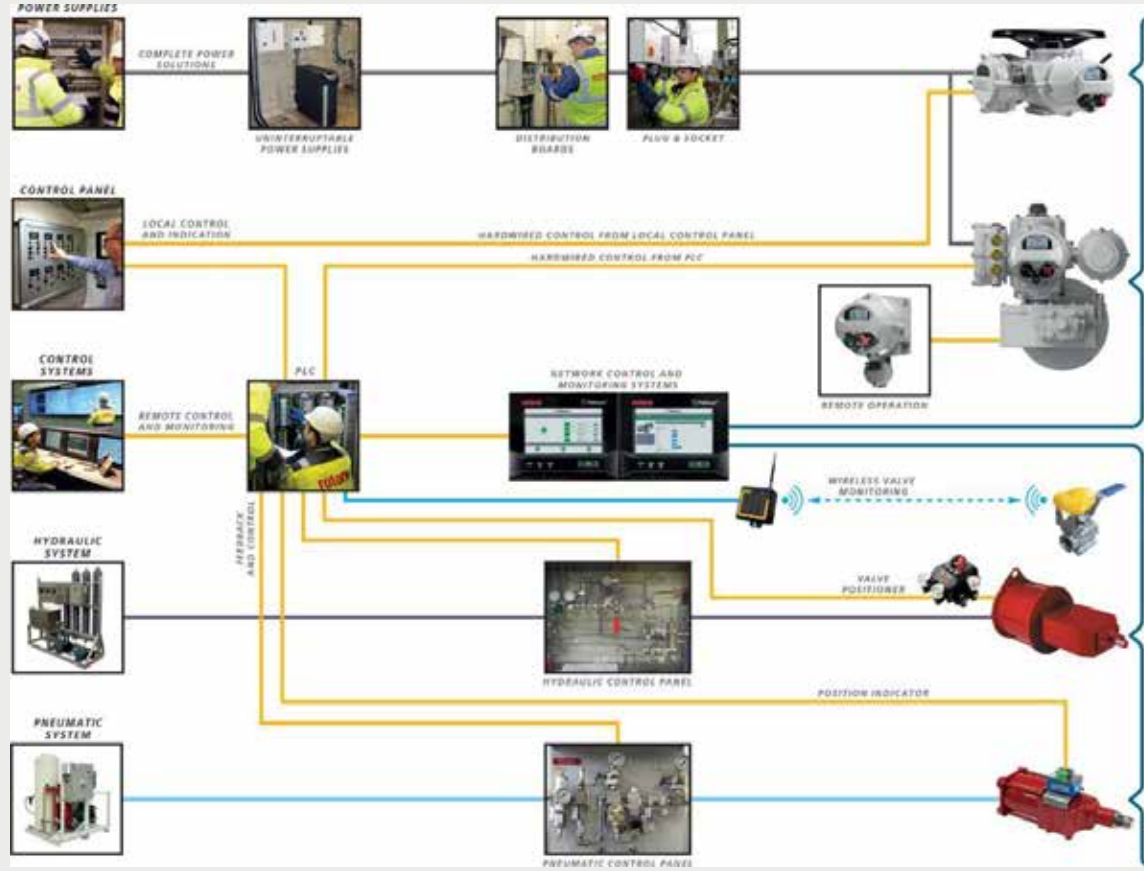

Modbus®

**PROFI
BUS**

HART
COMMUNICATION FOUNDATION

ASSET MANAGEMENT ve ÖNEMİ

VANA KONTROL SİSTEMLERİNDE ASSET MANAGEMENT

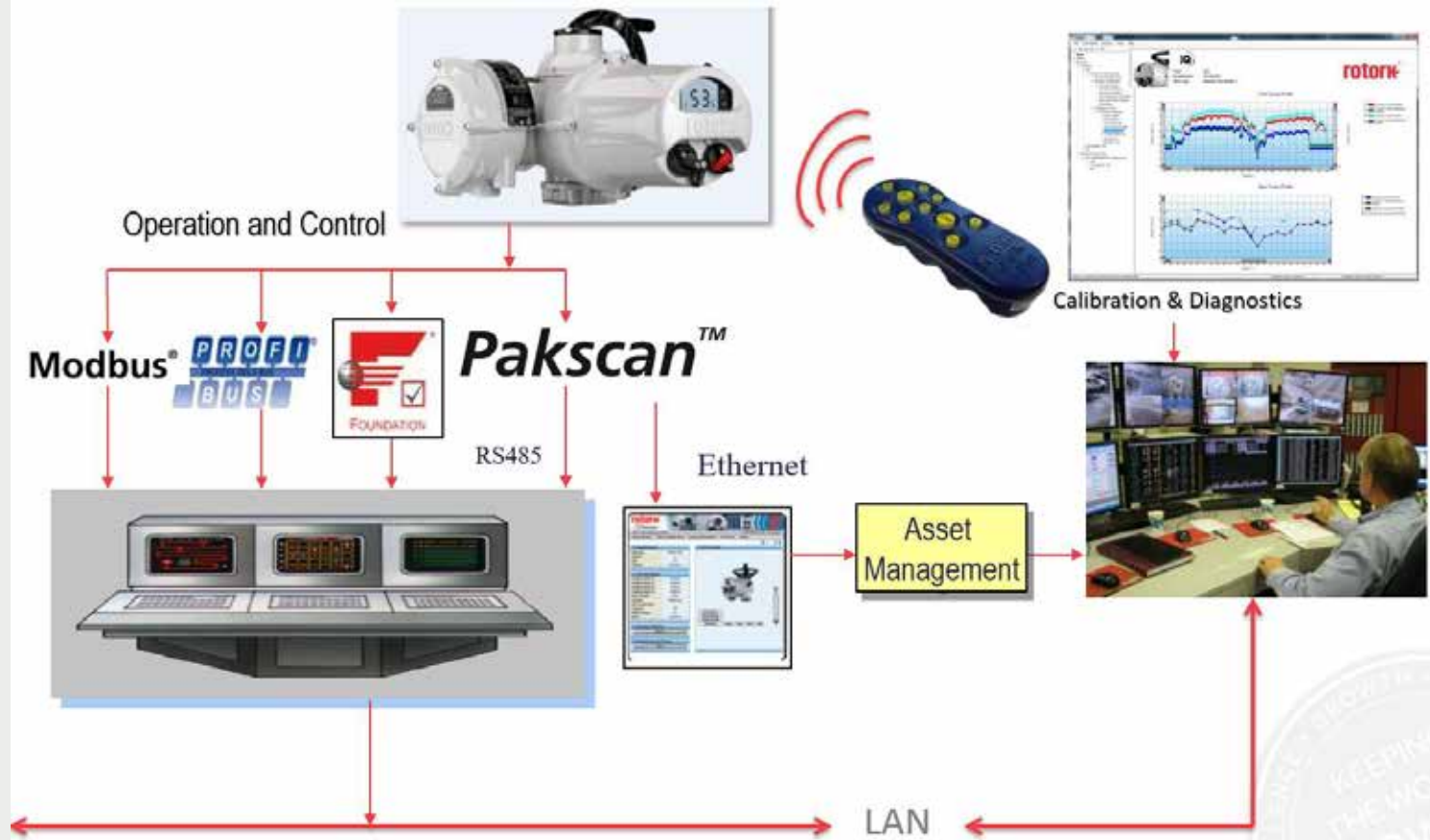

ASSET MANAGEMENT ve ÖNEMİ



Single: Çoklu sunucu bağlantısı ile birlikte çift yönlü alan kontrolü

Dual: 2 bağımsız ana istasyon ile yedeklemeli çift yönlü alan kontrolü

Hot standby: Tam yedeklemeli ve sürekli aktif PCB ünitesi ile çift yönlü kontrol sayesinde kart hatalarına karşı emniyetli



KOCAELİ SANAYİ ODASI

PROSES
EMNİYETİ SEMPOZYUMU